

Part Numbering:

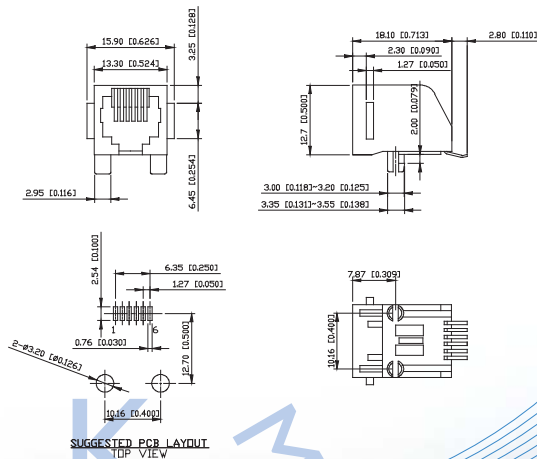

The above dimensions are for references only and are not to be used for design work. Please contact our sales people for the specification drawing for your application.

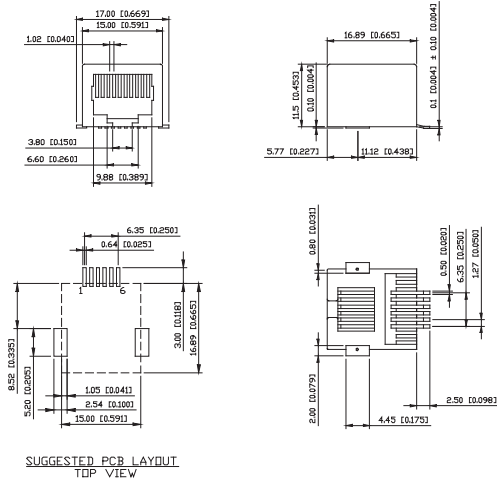
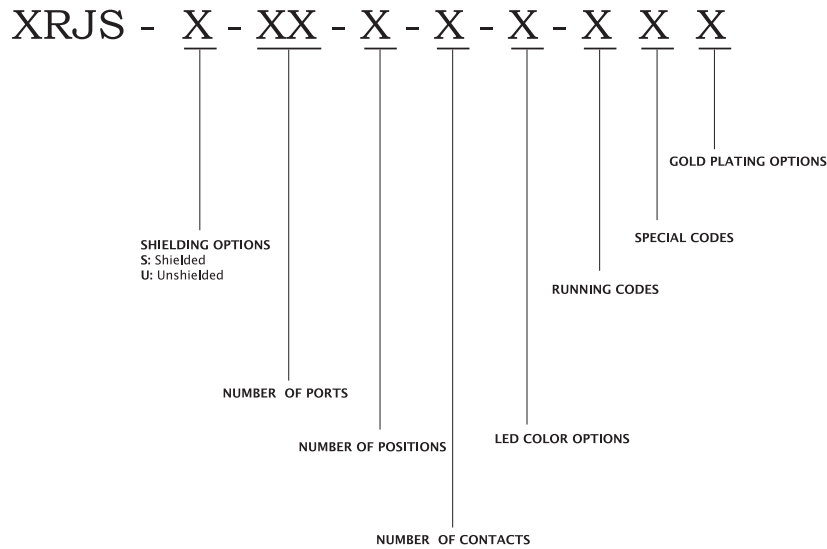
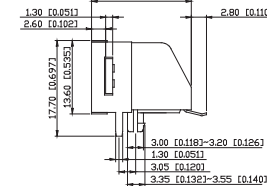
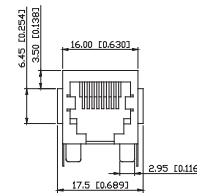
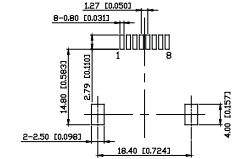
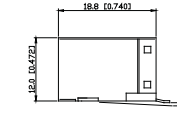
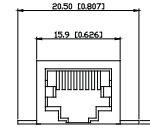
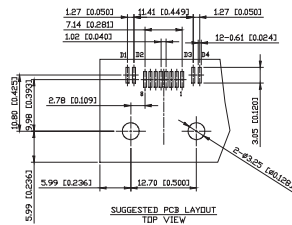
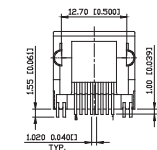
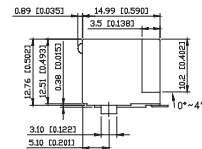
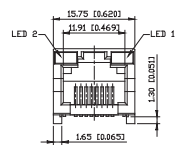
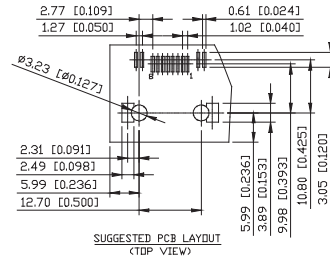
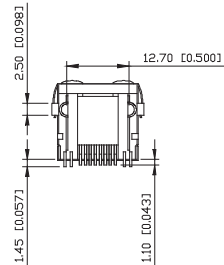
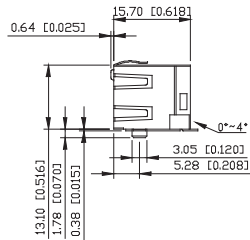
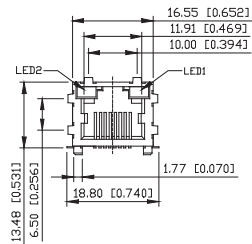

SUGGESTED PCB LAYOUT
TOP VIEW

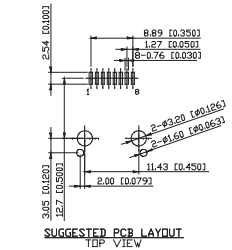

SUGGESTED PCB LAYOUT
TOP VIEW

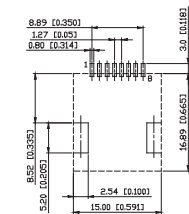
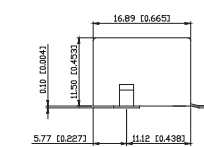
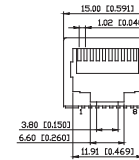

SUGGESTED PCB LAYOUT
TOP VIEW

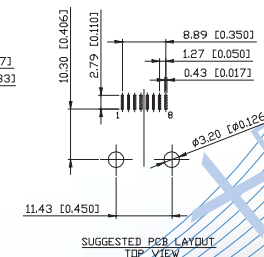
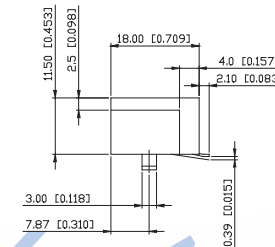
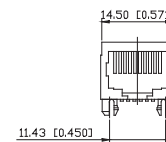

SUGGESTED PCB LAYOUT
TOP VIEW