

REVISION RECORD				
REV	ECD	DESCRIPTION	DRFT	CHKD

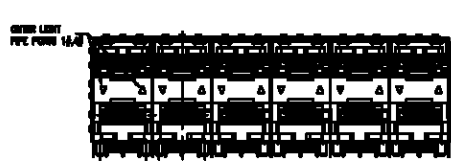

PART NUMBER
SFP026BL1

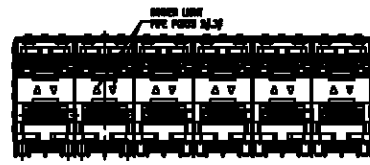

PART NUMBER
SFP026BL2

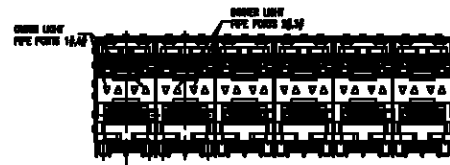

PART NUMBER
SFP026BL

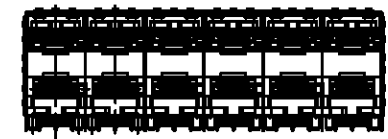

PART NUMBER
SFP026B

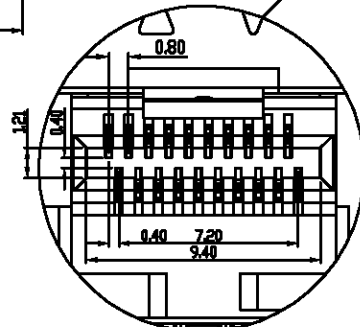
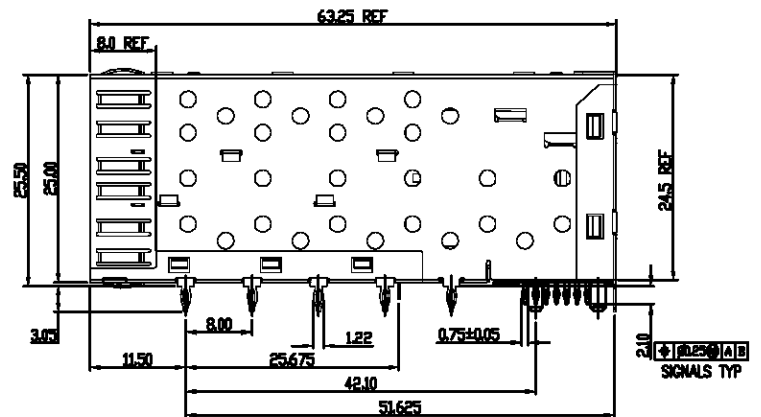
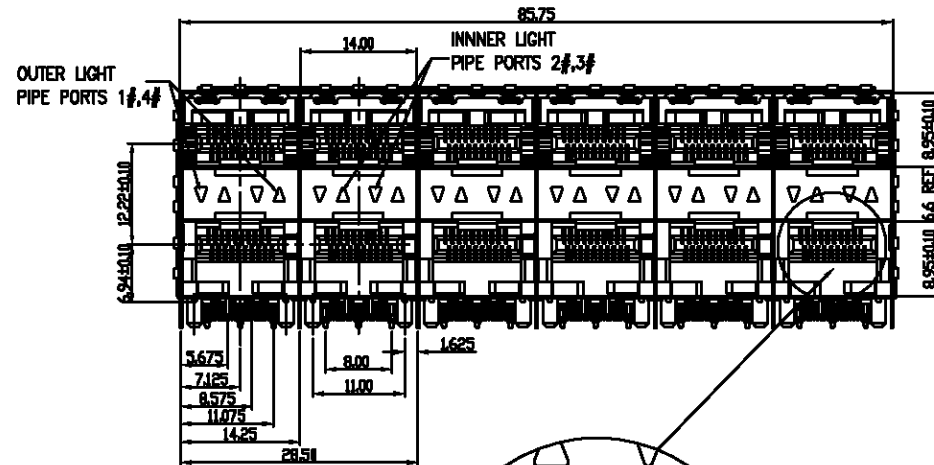

- NOTE:
- DESCRIPTION
01 SFP CAGE COPPER ALLOY
02 CONNECTOR CONTACTS GOLD PLATING
 - TEMPERATURE:
OPERATION: -40°C ~ +85°C
STORAGE: -40°C ~ +85°C
 - RoHS COMPLIANT
 - PART NUMBER : SFP026BL

Qty Per	TRAY	CARTON		
	6	30		
PART NUMBER	STATEMENT			
N/A	INNER/OUTER 4 PORTS LIGHT PIPES INNER 2 PORTS LIGHT PIPES OUTER 2 PORTS LIGHT PIPES			
No.	DESCRIPTION	Q'ty	MATERIAL	PLATING
01	SFP CAGE (Non-Logo)	1	COPPER ALLOY	NICKEL
02	CONNECTOR	6		GOLD
03	LIGHT PIPES	6	POLYCARBONITE	

DETACHED LISTS	MM CIRCDS	DFTD JERRY	DATE 03/05/08	Xmultiple Technologies, Inc.			
	TOLERANCES EXCEPT AS NOTED	CHKD	DATE				
		MFD	DATE				
		APPVL	DATE				
	MM A ± 0.20 Ø ± 0.15 Ø ± 0.075			MATERIAL :	TITLE		
	ANGLES ±	QT'Y :			SFP CAGE 2X6 PORT WITH LIGHT PIPE		
	THIRD ANGLE PROJECTION	FINISH:			DRAWING NO. SFP-026B	SIZE A3	REV 0
		SCALE :			/PART NO. SEE NOTE		
					DO NOT SCALE DRAWING	SHEET X	OF Y

REVISION RECORD				
REV	ECD	DESCRIPTION	DRAFT	CHKD

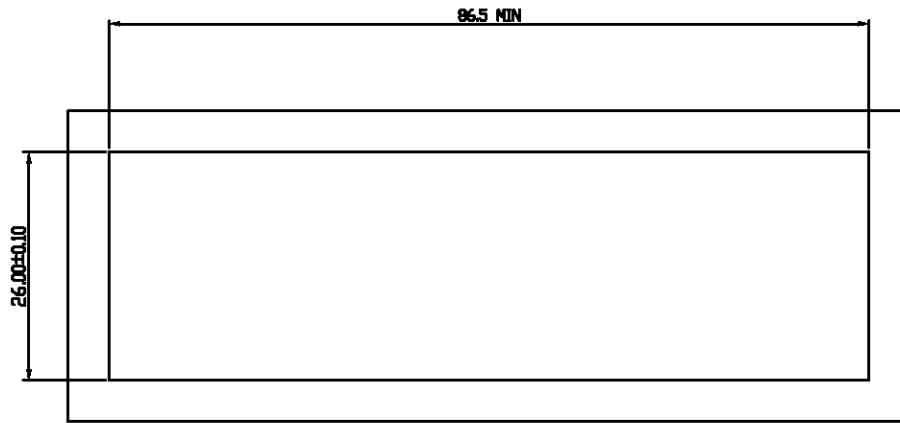

BEZEL CUT-OUT CENTER SPACING DETAIL
BEZEL THICKNESS:0.8-2.6

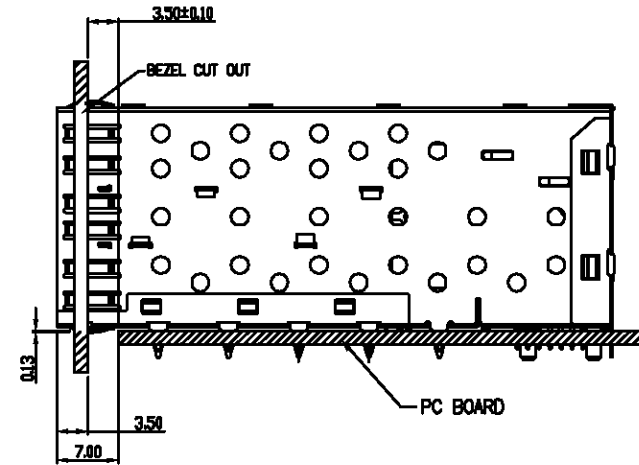

TOLERANCES EXCEPT AS NOTED MM .3 ± 0.08 .60 ± 0.15 .800 ± 0.075 ANGLES * THIRD ANGLE PROJECTION	IFTD. JERY CHKD	DATE 02/26/08 DATE	Xmultiple Technologies, Inc.		
	APPVL	DATE	TITLE SFP CAGE 2X6 PORT WITH LIGHT PIPE		
	MATERIAL :	QT'Y :	DRAWING NDL SFP-026B /PART NDL SEE NOTE	SIZE A3	REV 0
	FINISH:	SCALE :	DO NOT SCALE DRAWING	SHEET X OF Y	A

8 | 7 | 6 | 5 | 4 | 3 | 2 | 1

REVISION RECORD				
REV	ECD	DESCRIPTION	DRFT	CHKD

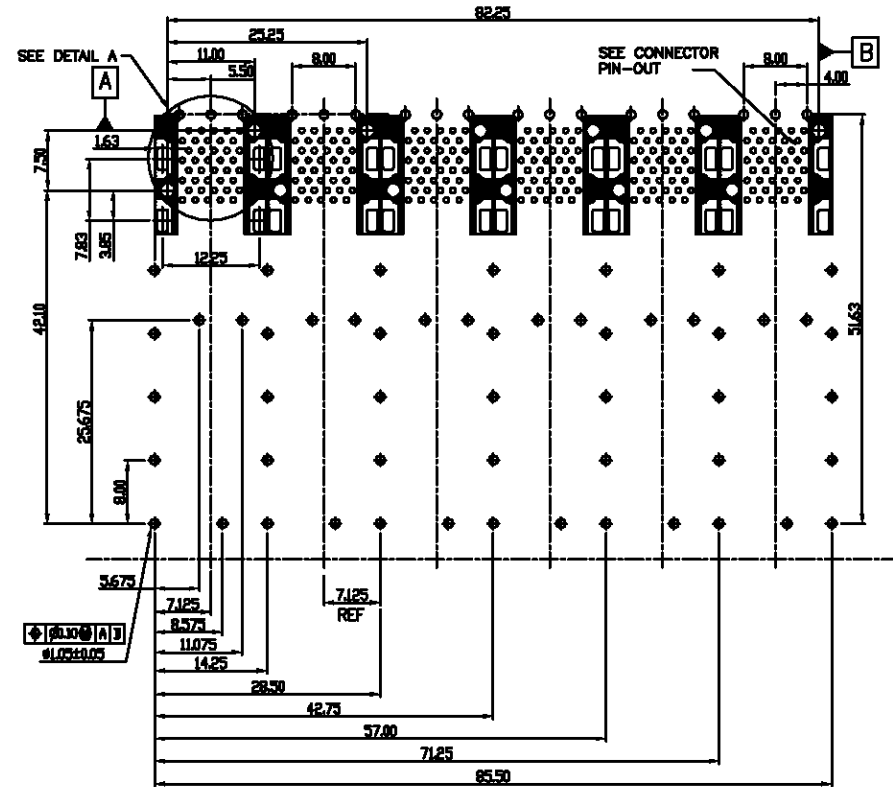
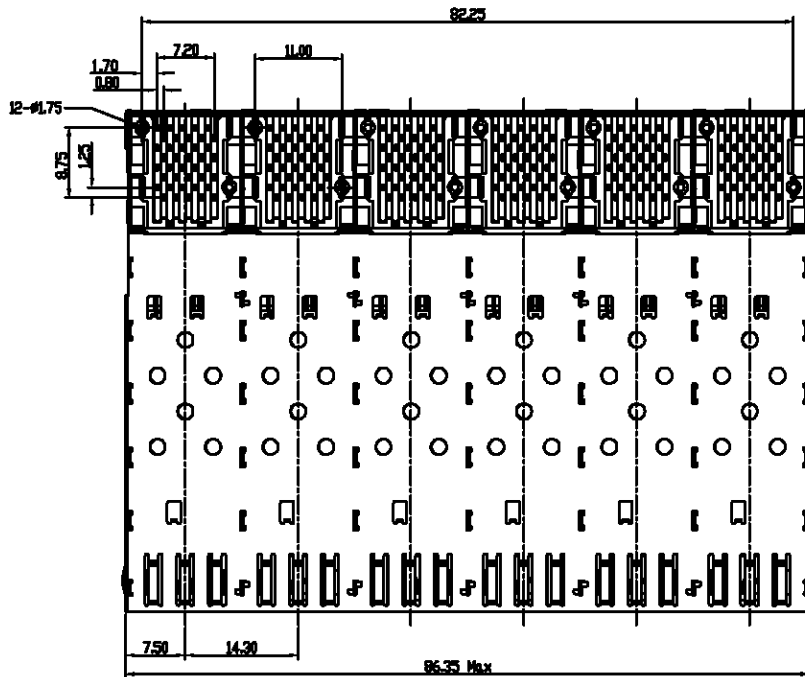

DETACHED LISTS DIM .4 ± 0.08 * .20 ± 0.10 * .000 ± 0.075 * ANGLES ± THIRD ANGLE PROJECTION	DIM CHECKED	DFTD. ENGR DATE 03/25/00	Xmultiple Technologies, Inc.	
	TOLERANCES EXCEPT AS NOTED		CHKD DATE	TITLE SFP CAGE 2X6 PORT WITH LIGHT PIPE
	APPVL DATE		MFD DATE	
	MATERIAL		QT'Y	DRAWING NO. SFP-026B /PART NO. SEE NOTE
FINISH		SCALE	DO NOT SCALE DRAWING	REV O
SHEET X OF Y		SHEET X OF Y		

8 | 7 | 6 | 5 | 4 | 3 | 2 | 1

REVISION RECORD				
REV	ECD	DESCRIPTION	DRFT	CHKD

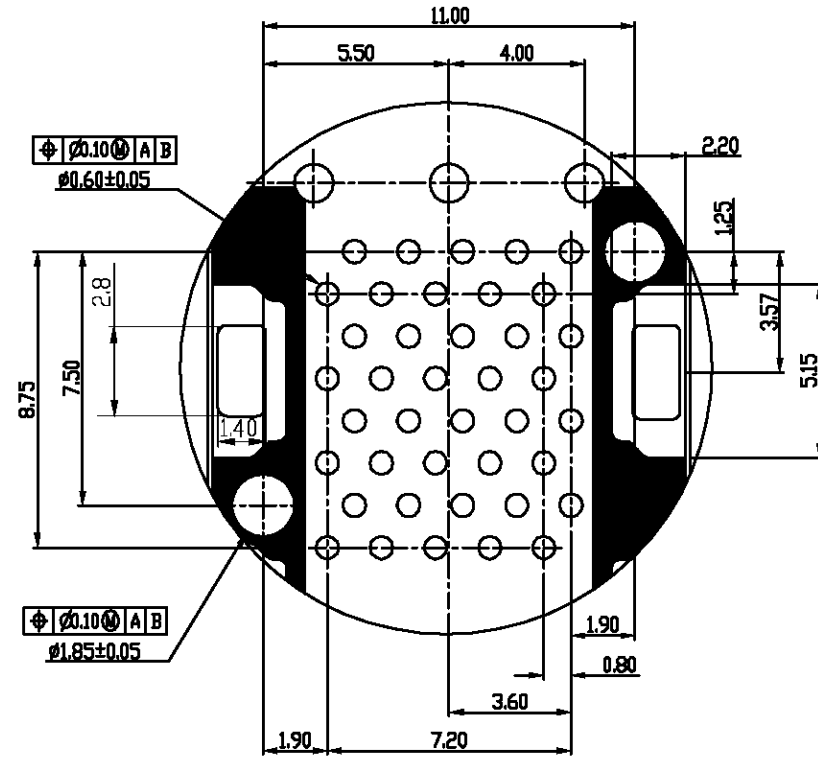
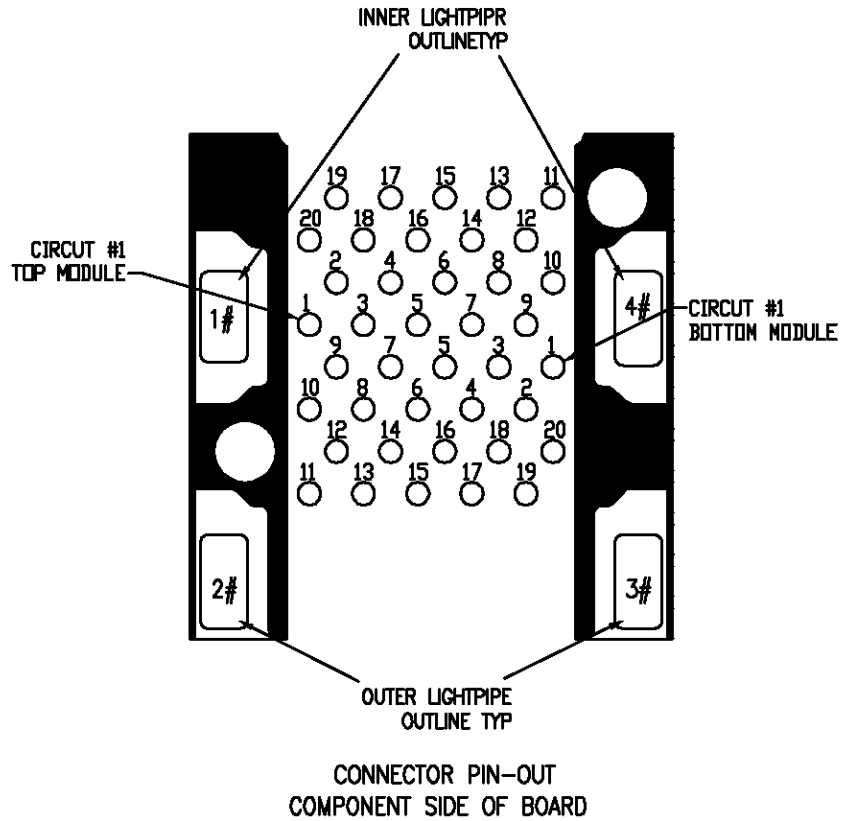

DETAIL A
SCALE 6:1

TOLERANCES EXCEPT AS NOTED MM UNLESS OTHERWISE SPECIFIED .1 ± .020 .30 ± .045 .003 ± .0075 ANGLES ±	DFTD JERRY CHKD WFD APPVL	DATE 02/15/00 DATE DATE DATE	Xmultiple Technologies, Inc. TITLE SFP CAGE 2X6 PORT WITH LIGHT PIPE DRAWING NO. SFP-026B /PART NO. SEE NOTE SHEET X OF Y
	MATERIAL :		
	QTY :		
	FINISH :		
THIRD ANGLE PROJECTION	SCALE :	SIZE A3 REV 0	DO NOT SCALE DRAWING