

ECN NO	REV	REVISIONS DESCRIPTION	APPVD	DATE
	A/0	INITIAL		

技术要求： 检验时需要100%导通、短、断路错位测试

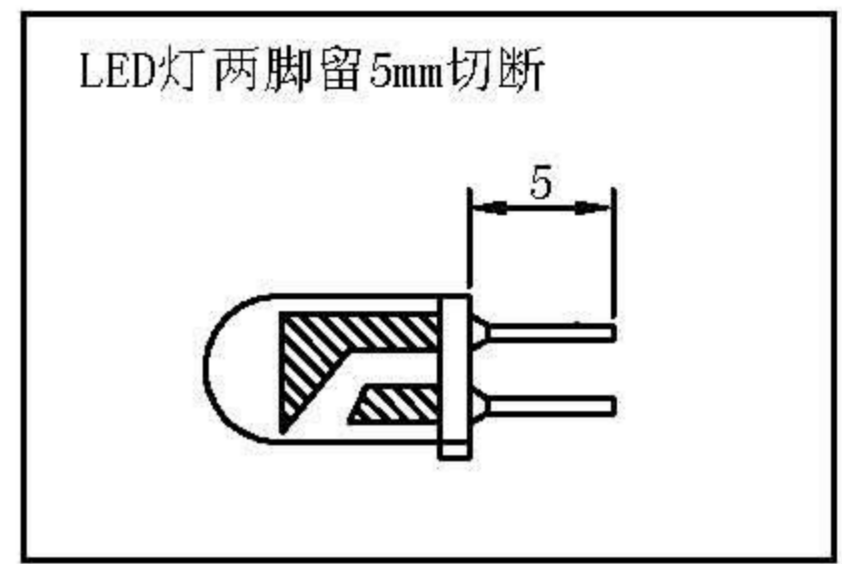
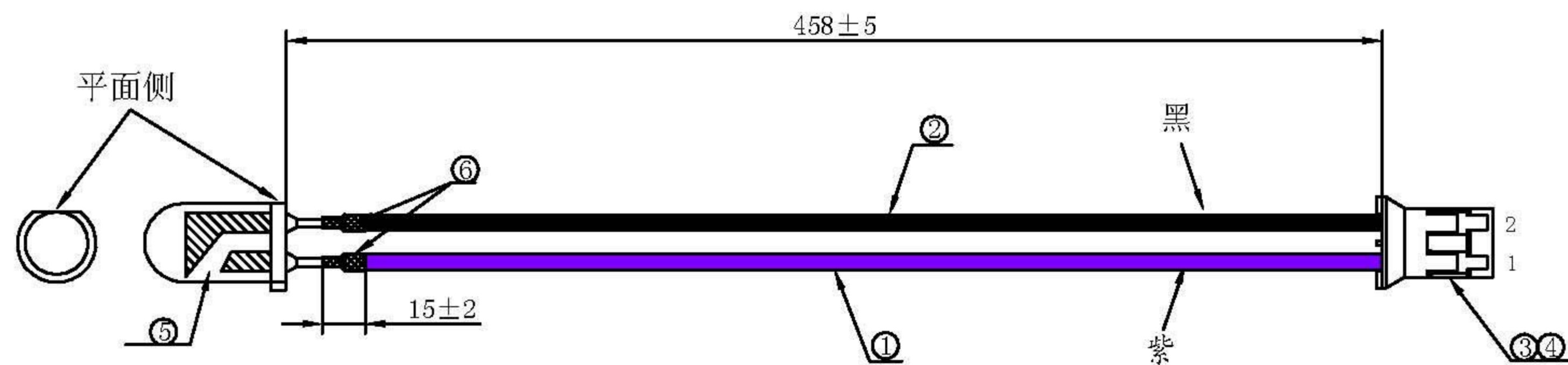

\*\*本产品符合RoHS环保要求\*\*

## XMULTIPLE TECHNOLOGY INC

客户料号 P/N	XCAB-004	产品名称 TITLE	UL1007 26# 紫黑 LED+PH-2Y L=458mm	
主件品号 ITEM No.		图纸编号 DWG NO.	HTDR-DF002-12103102	一般公差 TOLERANCE
制图 DRAWN	李梦洋 2012. 10. 31	视图 VIEW		
审核 EXAWINE	黄太保 2012. 10. 31	页次 SHEET		
核准 APPROVED		版本 REV	A/0	比例 SCALE
			mm	FREE

序号 NO.	规格型号 SPECIFICATION/MODEL	用量 QTY	单位 UNIT	颜色 COLOR	开线长度 TOTAL LENGTH	左剥头 LEFT LENGTH	右剥头 RIGHT LENGTH	供应商 SUPPLIER	备注 EXPLAIN
⑥	φ 1.5热缩管	2	PCS	黑	10				
⑤	LED (C503B-BCN-CVOZ0461)	1	PCS						客供
④	PH-T	2	PCS						
③	PH-2Y	1	PCS						
②	1007 26#	1	PCS	黑	460	3.0	2.5		
①	1007 26#	1	PCS	紫	460	3.0	2.5		