

MECHANICAL DIMENSIONS :

Part No:
XMH-RMS-D61-08W0-NL

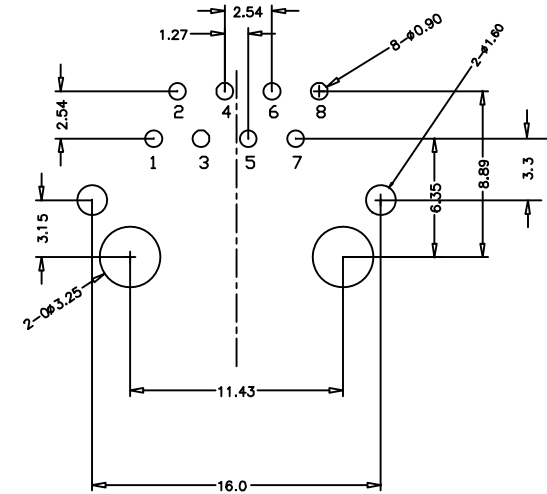

Suggested PCB Layout
(Component Side Shown)

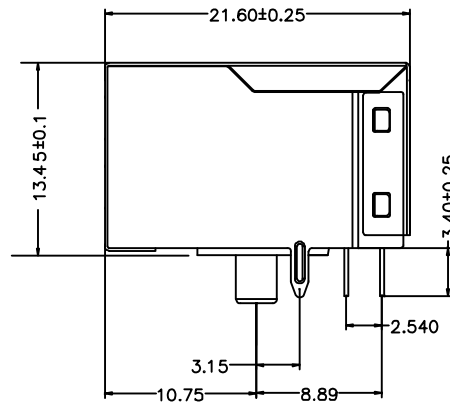
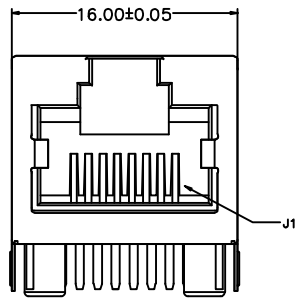
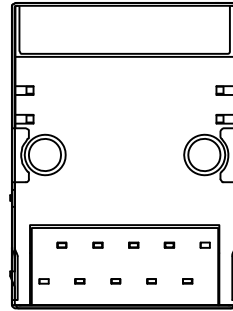
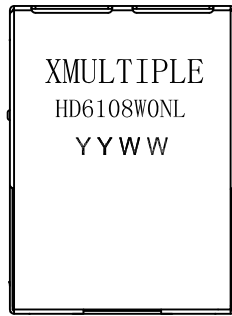
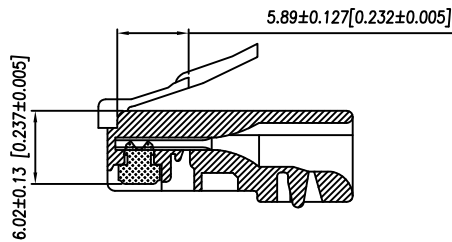

RECOMMENED PLUG DIMENSION

TOLERANCE UNSPECIFIED	
.0	±0.38
.00	±0.25
.000	±0.10
ANGLE	±3.00°
MANUFACTURING	COPY

RoHS Compliant

		CONNECTING THE INFORMATION AGE	
THIS DRAWING IS A CONTROLLED DOCUMENT.			
TITLE: RJ45 Connectors, W/O LED, Shielded/Thru Hole/10/100Mbps /FILTER		G/NO:	
PART NO: XMH-RMS-D61-08W0-NL		DWG NO: XMH-RMS-D61-08W0-NL	
		DRAWN: June	
UNIT: mm[inch]		SHEET: 1 of 2	
REV: 01		CHKD: Michael	
DATE: 2012/3/18		DATE:	

Feature:

- . Complies with IEEE standards and all 10/100Mbps Ethernet specifications including 350uH with 8mA DC bias
- . Intergrated Mag-modular design provides higher reliability and conserves minimizing PCB space
- . Housing: Thermoplastic PBT UL94V-0 rated,Color:black
- . Contact :Phosphor Bronze C5191,Thickness=0.35mm plated Nickel 30u" Min, Gold plated on content area 3u" Min
- . Input Terminal : Brass ,Thickness=0.35mm
- . Finish : 120n" min Tin over 50n" min Nickel
- . Metal shielding: Copper alloy with Nickel plated(C2680), Thickness=0.20mm Ni 30u" Min
- . Shell (the back cover): stainless steel 301
- . Different color of LEDs option available
- . Operating temperature: -20°C to +85°C
- . Storage temperature: -40°C to +85°C

Electrical Specifications: (25°C)

1. Turns Ratio: TX & Rx= 1:1 ± 3%	4. Common Mode Rejection: @1~100MHz: -30dB Min
2. Insertion Loss: @1~100MHz : -1.0dB Max	@200MHz: -20dB Min
3. Return Loss: @ 1~30MHz : -20dB Min @ 30~60MHz : -15dB Min	5. Crosstalk: @1~100MHz : -30dB Min
	6. OCL: @100KHz, 0.1V 8mADC : 350uH Min
	7. Hi-Pot : 1500V AC, 1mA, 60 Sec



SCHMATICS

CONNECTOR SOLDER SIDE

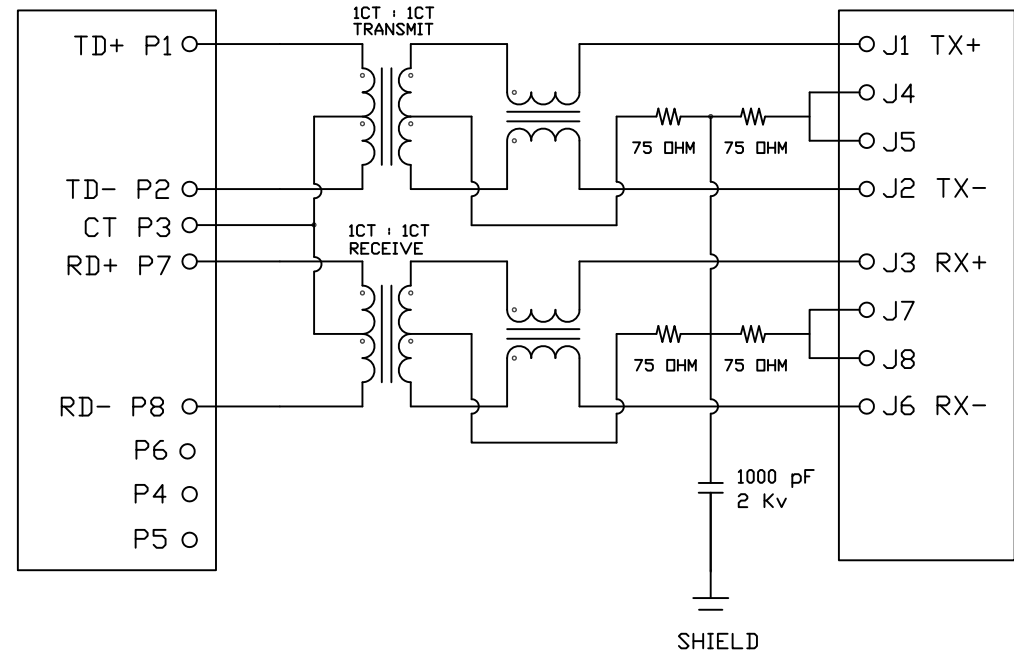
RJ45 CONTACT SIDE



RoHS Compliant

X MULTIPLE			CONNECTING THE INFORMATION AGE	
Xmultiple Technologies, Inc.1060 Los Angeles Avenue Simi Valley, CA 93065			G/NO:	
THIS DRAWING IS A CONTROLLED DOCUMENT.			DWG NO: XMH-RMS-D61-08W0-NL	
TITLE: RJ45 Connectors, W/O LED,Shielded/Thru Hole/10/100Mbps /FILTER			DRAWN: June	
PART NO: XMH-RMS-D61-08W0-NL			CHKD: Michael	
 		UNIT mm[inch]	SHEET 2 of 2	REV 01
			DATE: 2013/3/18	